

## Taper roller conveyor

### SRTC220/320 (Small diameter type)

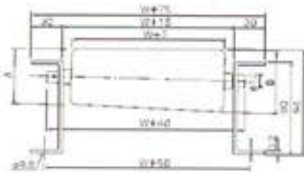

### SRTC700/900 /1200/1600

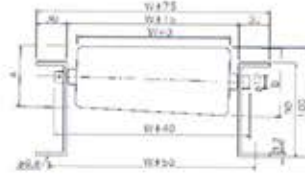

### SRTC220, SRTC320 (Small diameter type)



#### SRTC220

Roller width W (mm)		200
Small diameter A (mm)	Roller outside diameter	31.3
	Thickness	3.5
Large diameter B (mm)	Roller outside diameter	60.5
	Thickness	2

#### SRTC320

Roller width W (mm)		300
Small diameter A (mm)	Roller outside diameter	31.2
	Thickness	3.6
Large diameter B (mm)	Roller outside diameter	60.5
	Thickness	2.1

Model	Curve Inside R	Frame Shape lxKxt Conveyor Height (H)	Roller Width W	Spaces Between rollers P (number of rollers)	Conveyor Angle	Conveyor Strength (kg)	Approx. conveyor weight (kg)
SRTC220	220	12x1.0 pipe semicircle	90x30x3.2 94	200	50(10) 75(7) 100(5)	90°	10.0 [75P]
SRTC320	320	12x1.0 pipe semicircle	90x30x3.2 94	300	50(15) 75(10) 100(7)	90°	15.4 [75P]

### SRTC700, SRTC900, SRTC1200, SRTC1600

#### SRTC700

Roller width W (mm)		200	300	400	500	600
Small diameter A (mm)	Roller outside diameter	41.3	41.3	41.3	41.3	41.3
	Thickness	3.3	3.3	3.3	3.3	3.3
Large diameter B (mm)	Roller outside diameter	52.2	57.6	63.1	68.6	74.0
	Thickness	2.5	2.4	2.4	2.3	2.3

#### SRTC900

Roller width W (mm)		200	300	400	500	600
Small diameter A (mm)	Roller outside diameter	45.0	45.0	45.0	45.0	45.0
	Thickness	3.2	3.2	3.2	3.2	3.2
Large diameter B (mm)	Roller outside diameter	54.9	59.9	64.9	69.8	74.8
	Thickness	2.2	2.2	2.1	2.1	2.0

#### SRTC1200

Roller width W (mm)		200	300	400	500	600
Small diameter A (mm)	Roller outside diameter	48.0	48.0	48.0	48.0	48.0
	Thickness	3.1	3.1	3.1	3.1	3.1
Large diameter B (mm)	Roller outside diameter	56.8	61.2	65.7	70.1	74.5
	Thickness	2.3	2.3	2.2	2.2	2.1

#### SRTC1600

Roller width W (mm)		400	500	600	700	800
Small diameter A (mm)	Roller outside diameter	50.0	50.0	50.0	50.0	50.0
	Thickness	3.0	3.0	3.0	3.0	3.0
Large diameter B (mm)	Roller outside diameter	63.0	66.3	69.5	72.8	76.0
	Thickness	2.3	2.2	2.2	2.1	2.0

(Unit: mm)

Model	Curve Inside R	Shaft Outside Diameter (Φ) x Thickness (t) Machining	Frame Shape l x K x t Conveyor Height	Roller Width (W)	Spaces between rollers Pl (Number of Roller)	Conveyor Angle	Conveyor Strength (kg)	Approx. Conveyor weight (kg)
SRTC700	700	12x1.0 Pipe Semi Circle	□90x30x3.2 100	200~600 free size	75(20),100(15) 150(10)	90°	80 [400W]	48.2 [400W.75P]
SRTC900	900	12x1.0 Pipe Semi Circle	□90x30x3.2 100	200~600 free size	75(23),100(18) 150(12)	90°	80 [400W]	55.9 [400W.75P]
SRTC1200	1,200	12x1.0 Pipe Semi Circle	□90x30x3.2 100	200~600 free size	75(31),100(23) 150(15)	90°	80 [400W]	73.7 [400W.75P]
SRTC1600	1,600	12x1.0 Pipe Semi Circle	□90x30x3.2 100	400~800 free size	75(41),100(31) 150(21),200(15)	90°	80 [400W]	96.4 [400W.75P]



# Special roller

## Special

### Rubber-lining roller

Having an effect to prevent the bottom face of carried objects from being damaged.



Lining type	Hardness	Oil resistance	Characteristic	Rubber thickness	Applied roller
① Natural rubber Black	About 60	None	Commonly used lining	3t, 5t	19, 28, 38 42, 57, 60
② Urethane rubber	About 90	Good	Excellent abrasion resistance		

Lining type	Thick-ness	Applied roller diameter			Material	Hardness (JIS-A)	Heat resistance	Cold resistance	Oil resistance	Weather resistance, Abrasion resistance
		Black	Gray	Transparent						
③④ Shrinkable tube lining	1.8t	19	-	-	Soft PVC	75 or above (after shrinking)	85°C	-10°C	Almost no influence	Good
	2.0t	28	-	19, 28						
	2.5t	-	-	28						
	3.5t	38, 42, 57, 60			Soft PVC					
		38, 42, 57, 60 (light grey)			Polyurethane					

### Drive roller

SRC384010TS

SRC384010TW

SRC574010TS

SRC574010TW



(Unit: mm)

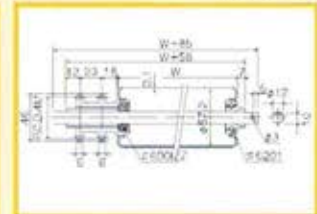
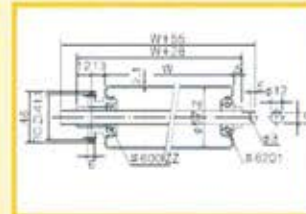
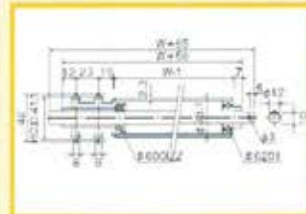
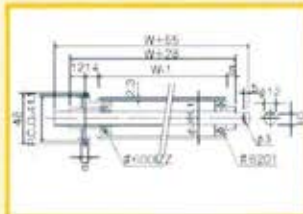

Model	Roller Dimension	Shaft Type	Sprocket	Roller Width	Remarks
SRC384010TS	Φ38.1x2.3 plated #6201 with boss	12 polished round bar round, semi circle	#40x10 teeth Single	100 to 1500 free size available	Resin boss attached
SRC384010TW	Φ38.1x2.3 plated #6201 with boss	12 polished round bar round, semi circle	#40x10 teeth Double	100 to 1500 free size available	Resin boss attached
SRC574010TS	Φ57.2x2.1 plated #6201 with boss	12 polished round bar round, semi circle	#40x10 teeth Single	100 to 1500 free size available	Resin boss attached
SRC574010TW	Φ57.2x2.1 plated #6201 with boss	12 polished round bar round, semi circle	#40x10 teeth Double	100 to 1500 free size available	Resin boss attached

### Stepped-upper face ball caster KK-25S

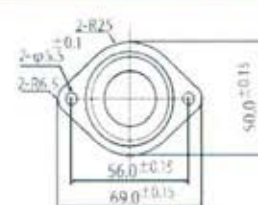
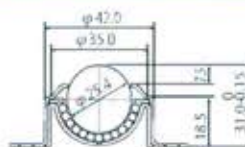

Withstand load

20kg

## Plate bearing SPB25



Model	Frame dimension	Frame length (mm)	Caster pitch	Withstand load (kg) per caster
SPB25	125x75x2.3	3000	76P	25

## Ball caster SB-25S

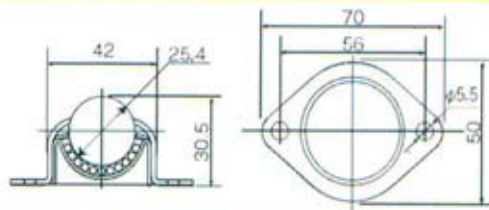

Withstand load

25kg



# Brake roller

## Mechanical brake roller

### SR-D57M Series

(60)

### Ultimate energy saving

Built-in speed controller

The mechanism is that centrifugal force generated by roller rotation actuates brake operation automatically.

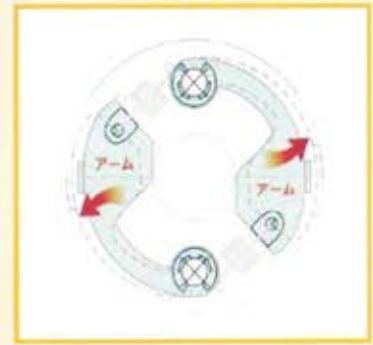

Model for Made-by-Shinmei roller conveyor

Model

Roller width of Made-by-Shinmei roller conveyor

\*When you order....

Model

SR-D57M  
(60)



- K

#### Numeral Condition

Conveyed Item : Plastic Pallets

Conveyor : SRC5712A 250W-75P (two rows)

MBR Pitch : conveyed item length + conveyor pitch (two rows)

- Please use a reinforcing plate (Φ12, Φ15)

#### Conveyance Speed Guide

Inclination Angle 1.5

Weight Type	15	20	25
500kg	10.5m/m	15m/m	-
300kg	8.5m/m	12m/m	16.5m/m
100kg	5.5m/m	7.5m/m	10.5m/m
75kg	-	6m/m	9m/m

Inclination Angle 2.0

Weight Type	15	20	25
500kg	13m/m	-	-
300kg	10.5m/m	14.5m/m	20m/m
100kg	6.5m/m	9m/m	12m/m
75kg	5.5m/m	8m/m	11m/m

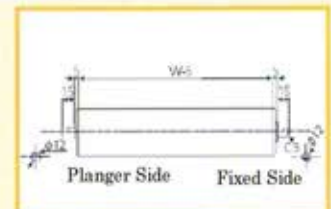

\*Use the reinforcement plate (separate order).

- Type (Type indicates braking torque of the built-in brake roller.)

	Type Number	Brake Roller Width
SR-D57M (shaft Φ 12)	8 . 10 . 13	250" ~ 1000" (by 50)
	15 . 20 . 25 . 30 . 35 . 45 . 80 . 90 . 100	200" ~ 1000" (by 50)
SR-D60M (shaft Φ 15)	15 . 20 . 25 . 30 . 35 . 45 . 80 . 90 . 100	200" ~ 1000" (by 50)

- Decide the followings to use them safely (type and amount)

① Inclination angle/Difference in the height	Degree _____ mm	⑤ Size of carried object	W= _____ mm L= _____ mm H= _____ mm
② Inclination part length	_____ mm	⑥ Weight of carried object	_____ kg
③ Roller diameter	φ57 . φ60	⑦ Material of carried object	Metal, Wood, Plastic, ( )
④ Roller pitch	75 . 100	⑧ Number of conveyor receiving port	One row, Two rows, Three rows

#### Slow conveyance type selection

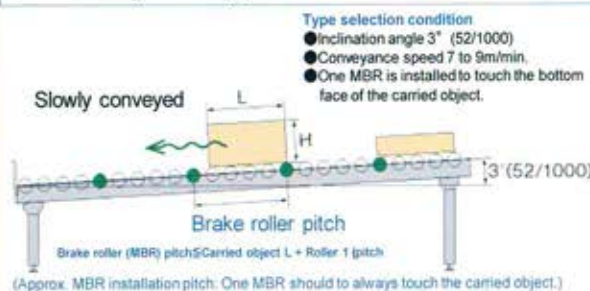

#### Pallet conveyance type selection

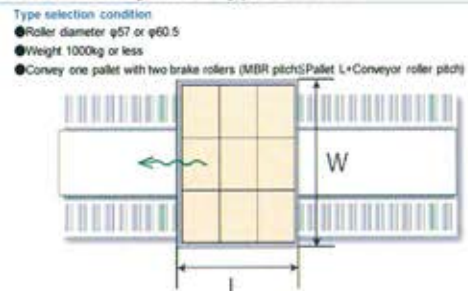



## Brake roller

### TYPE4027K

Carried object weight:  
25 to 800kg

\*Additionally order  
springs according to  
braking force, etc.



### TYPE4020K

Carried object weight:  
25 to 800kg

\*Additionally order  
springs according to  
braking force, etc.



(Unit: mm)

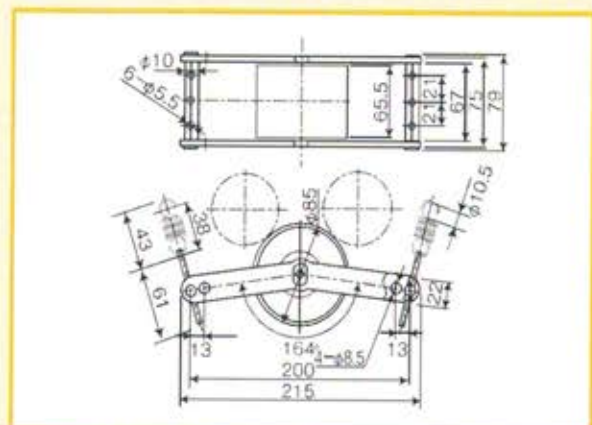
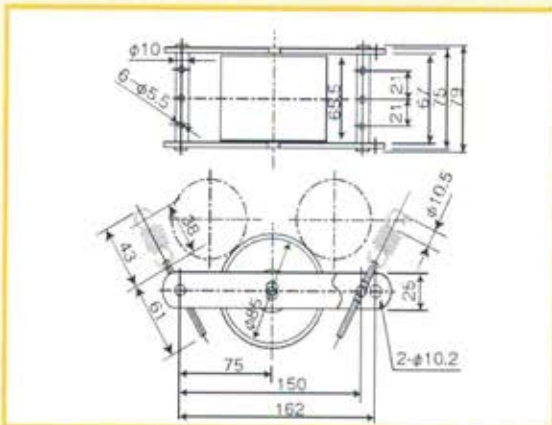

When installing brake rollers, two methods are available; direct installation which the rollers directly touch carried objects to control, and indirect installation which conveyor rollers touch carried objects to control the rollers and the objects indirectly.

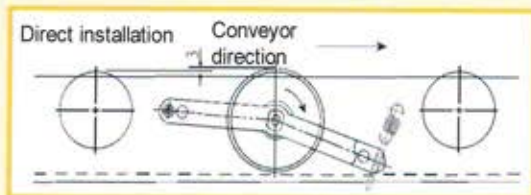

This method is suitable for the cases that a bottom face of the carried object is relatively flat, such as a package, a tray, or a pallet.

\*In this case, install the brake roller 1 mm to 3 mm higher than the upper face of the conveyor roller so that enough braking force is applied to carried objects. It is also necessary to adopt an installation method which enables to adjust the height according to the usage condition.

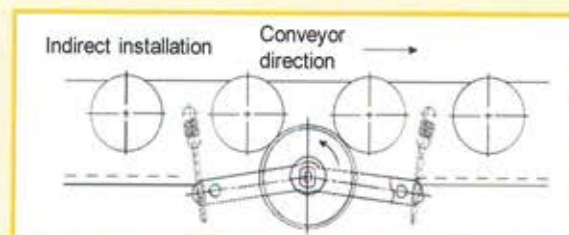

This method is suitable for the cases that there are spaces between conveyor rollers and carried objects such as a drum or an object which has no fixed form, or that necessary space to install brake rollers cannot be taken up between rollers.

\*It is possible to install the brake roller to one roller, but it is common to install it between rollers and make it contact with two rollers at the same time.

### ● Common installation pitch of brake roller

It is not necessarily fixed because of various conditions such as inclination angle, weight or shape of carried objects, or bearing type used. As shown in the right drawing, it is common to use one brake roller for one pallet. As a rough guide, there is no difference depending on installation methods; direct or indirect.

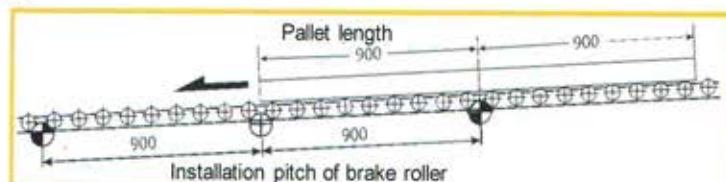

\*Inclination angle slightly differs depending on a carried object or conveyor shape.  $4\%$  ( $2.3^\circ$ ) is usually set as the standard.

\*Set the pallet approaching velocity at Max. 18m/min. or below.

## TYPE 2580C

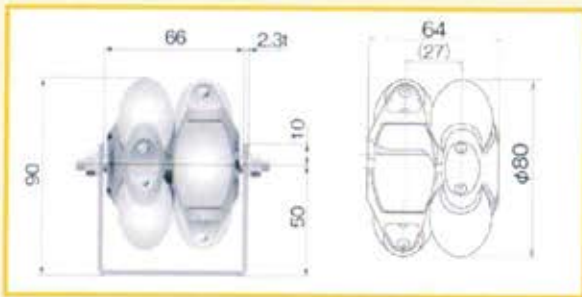

(Unit: mm)

Frame length (L)	1500
Frame dimension	□60x70.6x60x2.3 <sup>t</sup>
Roller	Ny lon
Roller Diameter	80
Roller pitch (P)	100
Shaft type	φ8 stepped round bar
Withstand load of one roller	50kg

## TYPE 2570C

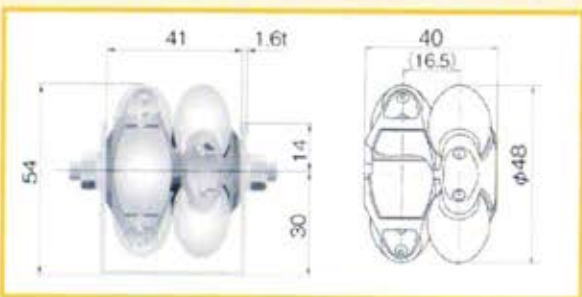

(Unit: mm)

Frame length (L)	1500
Frame dimension	□44x44.2x44x1.6 <sup>t</sup>
Roller	Ny lon
Roller Diameter	48
Roller pitch (P)	50
Shaft type	φ8 stepped round bar
Withstand load of one roller	10kg

## Omni-Mat TYPE2800 . TYPE2801

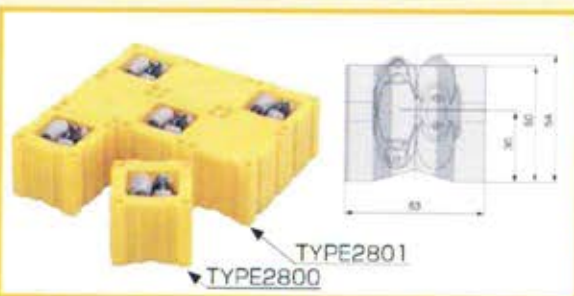

(Unit: mm)

<b>TYPE2800 (TYPE2570 Roller Attached)</b>	
Resin Case	Poly propylene 63x63x50
Roller	Nylon
Roller Diameter	48
Shaft type	φ8 round bar
Withstand load of one roller	10kg

**TYPE2801 (CLOSED TYPE)**

Resin Case	Poly propylene 63x63x50
------------	-------------------------

## Driving Omni-roller TYPE2530

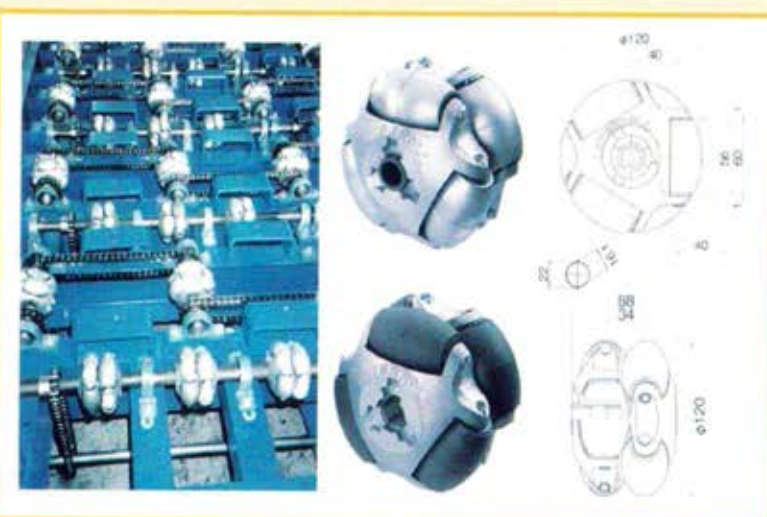

(Unit: mm)

<b>TYPE2530-4HX</b>	
Roller	Aluminium die-casting (ADC-12)
Roller Diameter	120
Shaft (Hexagonal Bar)	Opposite Side 19.2
Rotating Part Bearing Spec	Oilless bushing
Withstand load of one roller	100kg

(Unit: mm)

<b>TYPE2530-4HXU</b>	
Roller	Urethane
Roller Diameter	120
Shaft (Hexagonal Bar)	Opposite Side 19.2
Rotating Part Bearing Spec	Oilless bushing
Withstand load of one roller	100kg



## TYPE 2580C

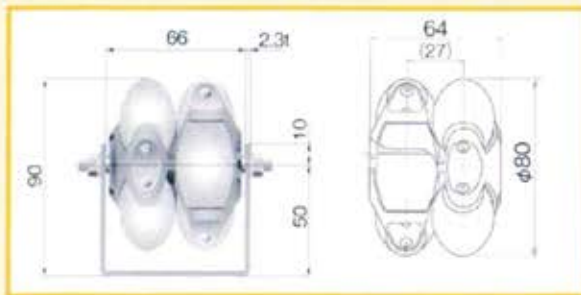

(Unit: mm)

Frame length (L)	1500
Frame dimension	□60x70.6x60x2.3 <sup>1</sup>
Roller	Nylon
Roller Diameter	80
Roller pitch (P)	100
Shaft type	φ8 stepped round bar
Withstand load of one roller	50kg

## TYPE 2570C

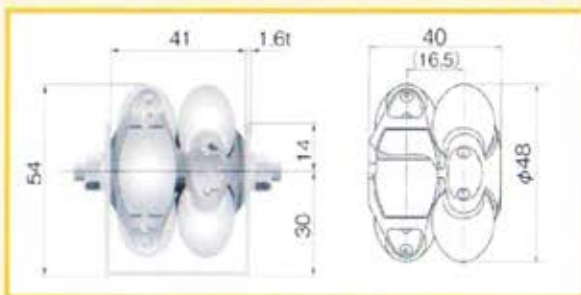

(Unit: mm)

Frame length (L)	1500
Frame dimension	□44x44.2x44x1.6 <sup>1</sup>
Roller	Nylon
Roller Diameter	48
Roller pitch (P)	50
Shaft type	φ8 stepped round bar
Withstand load of one roller	10kg

## Omni-Mat TYPE2800 . TYPE2801

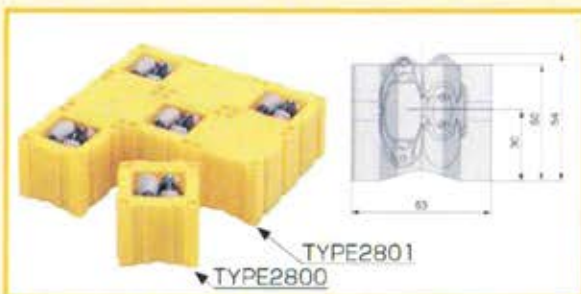

TYPE2800 (TYPE2570 Roller Attached) (Unit: mm)

Resin Case	Poly propylene 63x63x50
Roller	Nylon
Roller Diameter	48
Shaft type	φ8 round bar
Withstand load of one roller	10kg

TYPE2801 (CLOSED TYPE)

Resin Case	Poly propylene 63x63x50
------------	-------------------------

## Driving Omni-roller TYPE2530

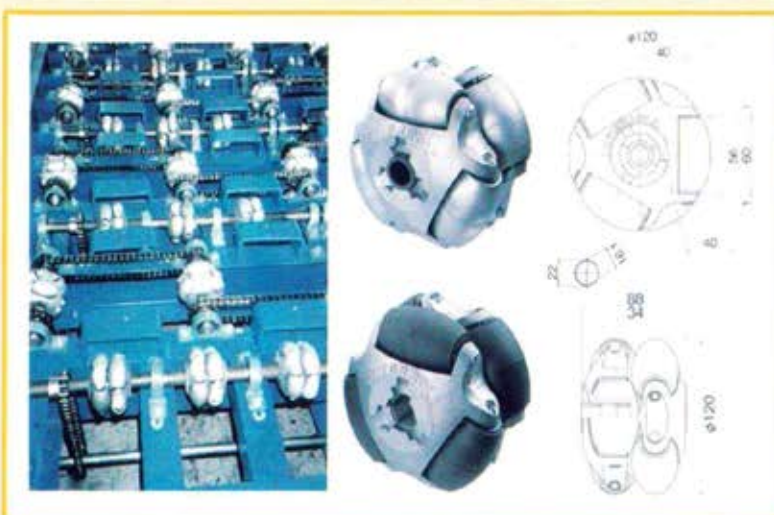

TYPE2530-4HX (Unit: mm)

Roller	Aluminium die-casting (ADC-12)
Roller Diameter	120
Shaft (Hexagonal Bar)	Opposite Side 19.2
Rotating Part Bearing Spec	Oiless bushing
Withstand load of one roller	100kg

TYPE2530-4HXU (Unit: mm)

Roller	Urethane
Roller Diameter	120
Shaft (Hexagonal Bar)	Opposite Side 19.2
Rotating Part Bearing Spec	Oiless bushing
Withstand load of one roller	100kg

# Auxiliary equipment

## 2B type stand (Standard type)

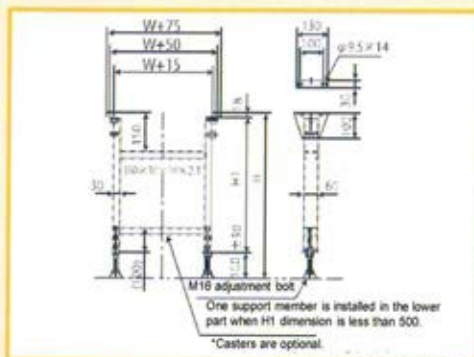

(Unit: mm)

Model	Minimum to Maximum H
No.1	130~180
No.2	230~290
No.3	310~410
No.3.5	360~460
No.4	410~510
No.4.5	460~560
No.5	510~610
No.5.5	560~660
No.6	610~710
No.6.5	660~760
No.7	710~810
No.7.5	760~860
No.8	810~910
No.9	910~1,010
No.10	1,010~1,110

\*Please specify that reinforcement pipes are necessary or not when ordering.

## Adjustment bolt

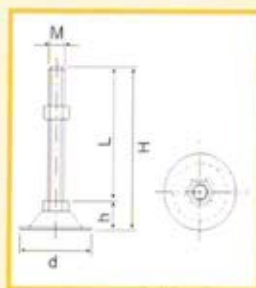

(Unit: mm)

M	d	h	L
M12	55	22	120-150
M16	75	28	130-180

## Adjustment bolt with anchor plate

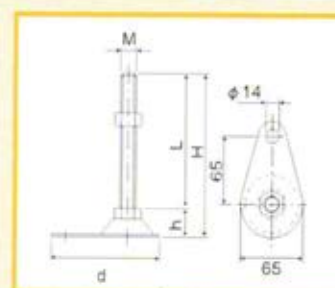

(Unit: mm)

M	d	h	L
M12	112	26	120-150
M16	112	28	130-180



# Omni-directional wheel

Realizing unprecedented movement

## Omni-directional wheel

Keeping omni-wheel function!!  
Installable as a wheel or a caster!!

"Unprecedented movement" is realized by making the best use of conventional "combination of outer wheel rotation (back-forth movement) and barrel-shaped roller (barrel) rotation (right-left movement) on the circumference" for the wheels!

Low starting resistance is achieved by adopting the precision bearing, and high withstand load performance is improved by the integral-type outer wheels.



Example when installed to a dolly



■ When moving from position A to position B

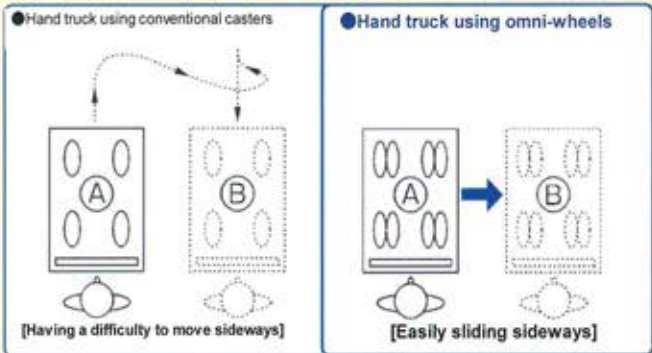

Newly designed as an omni-wheel for wheel.  
Low starting resistance is achieved by adopting the precision bearing, and high-load/impact-resistance performance are improved by the integral-type frame.



TFC125-7485-Asny

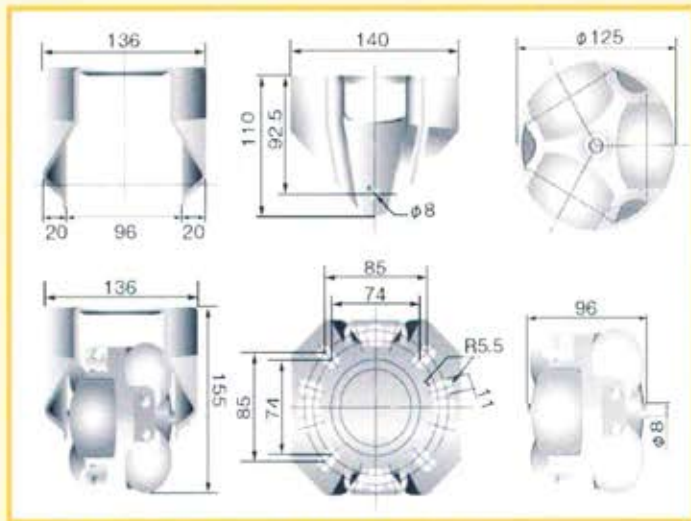

TFC-125-7485 (Frame for 2530-111WU)

Dimension	Material			Withstand load (kgf)	Rotating part bearing spec	
	Frame	Outer wheel	Barrel		Outer wheel	Barrel
136x140x155	Steel	Aluminum die casting	Polyurethane	120	Precision bearing	Precision bearing